

Vortex flow meter

Supmea

Headquarters

5th floor,Building 4,Singapore Hangzhou Science Technology Park,No. 6 street,
Hangzhou Economic Development Area,Hangzhou 310018,China

Singapore

2 Venture Drive #11-30 Vision Exchange Singapore

Philippines

Majestic Subdivision, Lot 1, 1800 Rainbow St, Marikina, 1811 Metro Manila, Philippines

✉ info@supmea.com

🌐 www.supmea.com

Supmea Automation Co.,Ltd.

Preface

Thank you for purchasing vortex flow meter. Please read this manual carefully before operating and using it correctly to avoid unnecessary losses caused by false operation.

Note

- Modification of this manual's contents will not be notified as a result of some factors, such as function upgrading.
- We try our best to guarantee that the manual content is accurate, if you find something wrong or incorrect, please contact us.
- This product is forbidden to use in explosion-proof occasions.

Version

U-YWJLUGB-MYEN2

Safety Precautions

In order to use this product safely, be sure to follow the safety precautions described.

About this manual

- Please submit this manual to the operator for reading.
- Please read the operation manual carefully before applying the instrument. On the precondition of full understanding.
- This manual only describes the functions of the product. The company does not guarantee that the product will be suitable for a particular use by the user.

Precautions for protection, safety and modification of this product

- To ensure safe use of this product and the systems it controls, Please read carefully the operation manual and understand the correct application methods before putting into operation, to avoid unnecessary losses due to operation mistakes. If the instrument is operated in other ways not described in the manual, the protections that the instrument give may be destroyed, and the failures and accidents incurred due to violation of precautions shall not be borne by our company.
- When installing lightning protection devices for this product and its control system, or designing and installing separate safety protection circuits for this product and its control system, it needs to be implemented by other devices.
- If you need to replace parts of the product, please use the model specifications specified by the company.
- This product is not intended for use in systems that are directly related to personal safety. Such as nuclear power equipment, equipment using radioactivity, railway systems, aviation equipment, marine equipment, aviation equipment and medical equipment. If applied, it is the responsibility of the user to use additional equipment or systems to ensure personal safety.
- Do not modify this product.

-
- The following safety signs are used in this manual:



Hazard, if not taken with appropriate precautions, will result in serious personal injury, product damage or major property damage.



Warning: Pay special attention to the important information linked to product or particular part in the operation manual.



- Confirm if the supply voltage is consistent with the rated voltage before operation.
- Do not use the instrument in a flammable and combustible or steam area.
- To prevent from electric shock, operation mistake, a good grounding protection must be made.
- Thunder prevention engineering facilities must be well managed: the shared grounding network shall be grounded at is-electric level, shielded, wires shall be located rationally, SPD surge protector shall be applied properly.
- Some inner parts may carry high voltage. Do not open the square panel in the front except our company personnel or maintenance personnel acknowledged by our company, to avoid electric shock.
- Cut off electric powers before making any checks, to avoid electric shock.
- Check the condition of the terminal screws regularly. If it is loose, please tighten it before use.
- It is not allowed to disassemble, process, modify or repair the product without authorization, otherwise it may cause abnormal operation, electric shock or fire accident.
- Wipe the product with a dry cotton cloth. Do not use alcohol, benzene or other organic solvents. Prevent all kinds of liquid from splashing on

the product. If the product falls into the water, please cut off the power immediately, otherwise there will be leakage, electric shock or even a fire accident.

- Please check the grounding protection status regularly. Do not operate if you think that the protection measures such as grounding protection and fuses are not perfect.
- Ventilation holes on the product housing must be kept clear to avoid malfunctions due to high temperatures, abnormal operation, shortened life and fire.
- Please strictly follow the instructions in this manual, otherwise the product's protective device may be damaged.



- Do not use the instrument if it is found damaged or deformed at opening of package.
- Prevent dust, wire end, iron fines or other objects from entering the instrument during installation, otherwise, it will cause abnormal movement or failure.
- During operation, to modify configuration, signal output, startup, stop, operation safety shall be fully considered. Operation mistakes may lead to failure and even destruction of the instrument and controlled equipment.
- Each part of the instrument has a certain lifetime, which must be maintained and repaired on a regular basis for long-time use.
- The product shall be scrapped as industrial wastes, to prevent environment pollution.
- When not using this product, be sure to turn off the power switch.
- If you find smoke from the product, smell odor, abnormal noise, etc., please turn off the power switch immediately and contact the company in time.

Disclaimer

- The company does not make any guarantees for the terms outside the scope of this product warranty.
- This company is not responsible for damage to the instrument or loss of parts or unpredictable damage caused directly or indirectly by improper operation of the user.

Package contents

Number	Name	Quantity	Remarks
1	Vortex flow meter	1	
2	Manual	1	
3	Certificate	1	

Table 1

After opening the box, please confirm the package contents before starting the operation. If you find that the model and quantity are incorrect or there is physical damage in appearance, please contact us.

Contents

Chapter 1 Introduction.....	1
Chapter 2 Working Principle.....	2
Chapter 3 Technical Parameters.....	4
Chapter 4 Product Dimension.....	8
Chapter 5 Model Selection.....	11
5.1 LUGB-B Model and function selection.....	11
5.2 LUGB-B vortex flow meter measurable liquid of different density corresponding with flow range under working condition.....	13
5.3 LUGB-A Model and function selection.....	16
5.4 LUGB-A pipeline-version vortex flow meter measurable flow range	19
5.5 LUCB-A insertion-version vortex flow meter measurable flow range under working condition.....	23
5.6 LUCB-A insertion-version vortex flow meter measurable medium flow range calculation.....	23
Chapter 6 Installation Instruction.....	25
Chapter 7 Wiring.....	29
Chapter 8 Interface Display.....	36
Chapter 9 Troubleshooting.....	42
Chapter 10 Parameter Setting.....	43
Chapter 11 Setting Of Signal Output.....	49
Chapter 12 Communication.....	51

Chapter 1 Introduction

Vortex flow meter is on the principle of Karman street, to measure liquid, gas and vapour even turbid liquid including micro grain and impurity. Applications: petroleum, chemical industry, paper making, metallurgy, electric force, environmental protection, food industry and etc.

Chapter 2 Working Principle

Vortex flow meter work on the principle of generated vortex and relation between vortex and flow by theory of Karman and Strouhal, which specialize in measurement of steam, gas and liquid of lower viscosity. As shown in below illustration, medium flows through bluff body and then vortex is generated, vortices are alternately formed on both sides with opposite directions of rotation, Vortices frequency is directly proportional to medium velocity. Through numbers of vortices that is measured by sensor head, medium velocity is calculated, plus flow meter diameter, final volume flow come out.

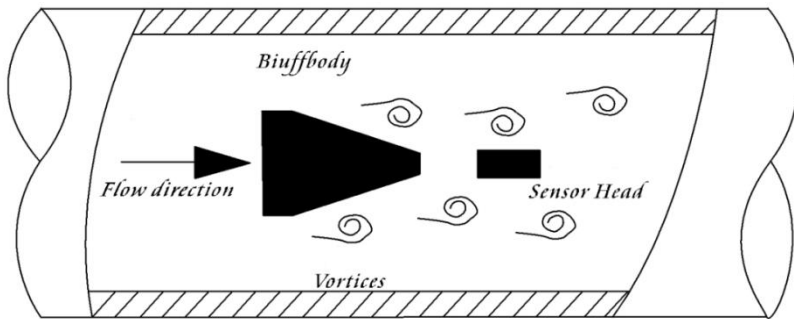

fig. 1

Computational formula as follows:

$$F = St \cdot V / md \dots\dots\dots \text{Formula 1}$$

$$Q = 3600 \cdot F / K \dots\dots\dots \text{Formula 2}$$

$$M = Q \cdot \rho \dots\dots\dots \text{Formula 3}$$

Among Formula:

F..... Fluid flow through bluff body generate frequency of vortex (Unit : Hz)

St... Strouhal constant (zero dimension)

V..... Mean velocity of fluid inside the pipeline (Unit : m/s)

m..... The ratio between Lune Circulation area of bluff body at both sides and cross-sectional area (Unit: zero dimension)

d..... Upstream face width of bluff body inside vortex flow meter (Unit : m)

D..... Inside diameter (ID) of vortex flow meter (Unit : m)

Q..... Instantaneous volume flow (Unit : m³ / h)

K..... Instrument coefficient of vortex flow meter (Unit : pulses / m³)

M..... Instantaneous mass flow (Unit : kg/ h)

ρ..... Fluid density (Unit : kg/ m³)

Note: vortex flow meter "K" coefficient is corresponding with one diameter, the exact "K" value

should be calibrated in practice. Viz. one cubic meter fluid through sensor output numbers of pulse under working condition.

Chapter 3 Technical Parameters

SUP-LUGB-B model

1. Medium: liquid, gas, steam(saturated steam and superheated steam)
2. Diameter
Pipeline-version: DN15-DN300
3. Accuracy:
Gas without compensation: DN15-DN25--1.5%, DN32-DN200--1.0%,
DN250-DN300--1.5%;
Liquid without compensation: DN15-DN300 -- 1.0%;
Temperature and pressure compensation: DN25-DN300 -- 1.5%
4. Range ratio:
Gas density:1.2kg/m³, Range ratio: 8:1
Liquid density:1000kg/m³, Range ratio: 8:1;
when the medium density is different, the range ratio will change.
5. Pressure:
Wafer connection: DN15-DN300 PN2.5MPa
Flange connection: DN15-DN50 PN2.5MPa
Flange connection: DN65-DN200 PN1.6MPa
Flange connection: DN250-DN300 PN1.0MPa
Note : Other pressure or other flange standards can be customized
6. Medium temperature
-40°C ~ +260°C、-40°C ~ +300°C
7. Ambient conditions:
Ambient temperature: -20°C~+55°C
8. Relative humidity (RH): 5% - 95%RH
9. Atmospheric Pressure: 86kPa -106kPa
10. Electrical Interface: M20*1.5 internal thread (priority).
11. Power supply: 24VDC±5%, lithium battery 3.6VDC
12. Signal output :
Instantaneous flow under working condition corresponding voltage-frequency-pulse output (lower PWL≤1V, higher PWL≥6V); Instantaneous flow corresponding 4-20mA output(Load resistance≤300 Ω)

13. Communication interface: RS485
14. Ingress protection: IP65
15. Main body material: stainless steel
16. Pressure loss: $\Delta P \leq 1.2 \rho_{\pm} V^2$ (ΔP unit is Pa, ρ_{\pm} unit is kg/m^3 , V unit is m/s)
17. Calibration method: all flow meters should be calibrated in the way of lower reaches taking pressure before flow meters leave factory.
18. Display mode:
Intelligent numeric alphabetic display type: twin-row numeric alphabetic LCD (instantaneous flow rate and totalizer)
Intelligent dot matrix LCD: English 128*64 dot matrix LCD (instantaneous flow rate, totalizer, temperature and pressure under working condition, battery voltage or density under working condition, instantaneous flow rate under working condition, send-out, time, menu modify records, power-off records, etc.)

SUP-LUGB-A model

1. Medium: liquid, gas, steam(saturated steam and superheated steam)
2. Diameter: Pipeline-version: DN10-DN500
Insertion-version: DN200-DN2000
3. Accuracy: Pipeline-version: 1.0% 1.5% (0.2% & 0.5% optional)
Insertion-version: 2.5% (1.0%&1.5% optional)
4. Flow range as per below table 2~6.
5. Pressure:
Pipeline-version wafer connection: DN10-DN500 (priority PN2.5MPa)
Pipeline-version flange connection: DN10-DN80 (priority PN2.5MPa)
DN100-DN200 (priority PN1.6MPa)
DN250-DN500 (priority PN1.0MPa)
Insertion-version attachment flange: DN200-DN2000 (priority PN1.6MPa)
Note : wafer-version vortex flow meter assemble made-to-order flanges, when flow meter leave factory including companion flanges. We are able to provide GB/T9119-2000, ANSI/ASME, DIN. JIS. KS....
Standard flanges (GB-China standard priority), pressure class recommend priority level.

6. Medium temperature:

Pipeline-version: $-40^{\circ}\text{C} \sim +160^{\circ}\text{C}$, $-40^{\circ}\text{C} \sim +280^{\circ}\text{C}$,
 $-40^{\circ}\text{C} \sim +350^{\circ}\text{C}$, $-40^{\circ}\text{C} \sim +420^{\circ}\text{C}$

Insertion-version: $-40^{\circ}\text{C} \sim +160^{\circ}\text{C}$ $-40^{\circ}\text{C} \sim +200^{\circ}\text{C}$

7. Ambient conditions: Ambient temperature $-20^{\circ}\text{C} \sim +60^{\circ}\text{C}$ (normal); $-20^{\circ}\text{C} \sim +40^{\circ}\text{C}$ (explosion-proof)

8. Relative humidity (RH): 5% - 95%RH

9. Atmospheric Pressure: 86kPa -106kPa

10. Electrical Interface: M20*1.5 internal thread (priority).

11. Power supply: 24VDC \pm 5%, lithium battery 3.6VDC

12. Signal output :

- Instantaneous flow under working condition corresponding voltage-frequency- pulse output (lower PWL \leq 1V, higher PWL \geq 6V)
- Instantaneous flow under standard condition corresponding voltage-frequency- pulse output (lower PWL \leq 1V, higher PWL \geq 6V)
- Instantaneous flow under standard condition pulse equivalent output (lower PWL \leq 1V, higher PWL \geq 6V)
- Instantaneous flow under working condition corresponding two-wire or three-wire 4~20mA output (load resistance \leq 300 Ω)
- Instantaneous flow under standard condition corresponding two-wire or three-wire 4~20mA output (load resistance \leq 300 Ω)

13. Communication interface: RS485 ; HART

14. Ingress protection: IP65 (IP67, IP68 optional)

15. Main body material: stainless steel

16. Pressure loss: $\Delta P \leq 1.2 \rho_{\pm} V^2$ (ΔP unit is Pa, ρ_{\pm} unit is kg/m³, V unit is m/s)

17. Calibration method: all flow meters should be calibrated in the way of lower reaches taking pressure before flow meters leave factory.

18. Display mode:

Intelligent numeric alphabetic display type: twin-row numeric alphabetic LCD (instantaneous flow rate and totalizer)

Intelligent dot matrix LCD: English 128*64 dot matrix LCD (instantaneous flow rate, totalizer, temperature and pressure under working condition, battery voltage or density under working condition, instantaneous flow rate under

working condition, send-out, time, menu modify records, power-off records,
etc.)

Chapter 4 Product Dimension

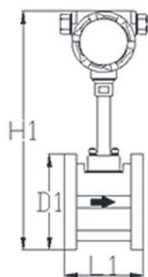

No.1: Wafer version(priority)

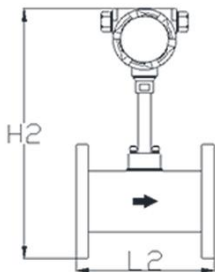

No.2: Flange version

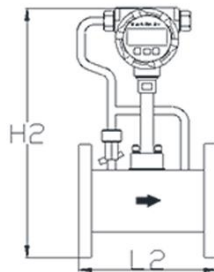

No.3: P&T compensation compact version

SUP-LUGB-B Vortex flow meter max configuration size fig.2

Size DN	H1 ^a	H1 ^b	H1 ^c	D1	L1	H2 ^a	H2 ^b	H2 ^c	L2
DN15	525	445	355	45	65	540	460	370	170
DN20	531	451	361	58	65	545	465	375	170
DN25	531	451	361	58	65	550	470	380	250
DN32	531	451	361	58	65	563	483	393	250
DN40	529	449	359	85	70	578	498	408	250
DN50	541	461	371	99	70	590	510	420	250
DN65	558	478	388	118	70	612	532	442	250
DN80	573	493	403	132	70	625	545	455	280
DN100	595	515	425	156	70	644	564	474	300
DN125	621	541	451	184	70	674	594	504	350
DN150	647	567	477	211	70	703	623	533	350
DN200	705	625	535	266	98	757	677	587	400
DN250	757	677	587	319	114	810	730	640	450
DN300	808	728	638	370	130	860	780	690	500

Note: This product has three kinds of pillars a, b, c, different lengths, you can check the height of the entire table corresponding to the H mark on the table above.

150°C sensor head without compensation vortex, use pillar c; 150°C sensor head with compensation vortex, use pillar b;

For 260°C sensor head vortex, use pillar b; for 300°C sensor head vortex, use pillar a.

SUP-LUGB-A Vortex flow meter max configuration size fig. 3 (unit: mm)

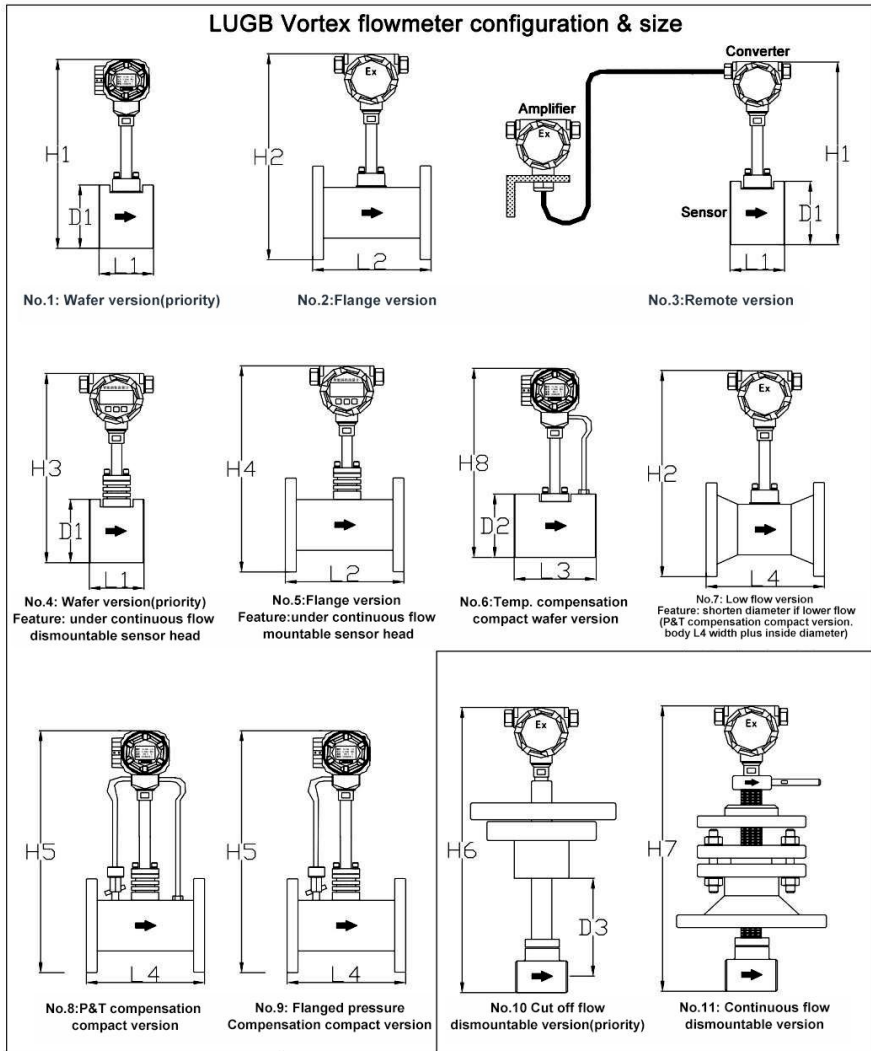

SUP-LUGB-A Vortex flow meter max configuration size table 2(unit: mm)

Dimension DN	H1	H2	H3	H4	H5	H6	H7	H8	D1	D2	D3	L1	L2	L3	L4
10	441	428							90			50	200		
15	445	430							95			50	200		
20	450	435							100			50	200		
25	451	440			455			428	100	60		50	200		275
32	456	452			468			432	105	65		54	200		275
40	435	468	477	505	505			477	92	92		78	200	112	275
50	438	480	484	518	518			484	98	98		78	200	112	275
65	453	502	495	535	535			495	110	110		78	200	112	275
80	476	515	519	550	550			519	134	134		90	225	112	300
100	499	534	543	571	571			543	158	158		78	250	112	350
125	520	564	560	599	599			560	175	175		78	275	112	375
150	545	593	585	631	631			585	200	200		100	300	140	400
200	595	647	635	682	682	530	1150	635	250	250	100	120	350	160	450
250	645	700	685	735	735	530	1150	685	300	300	125	140	400	180	500
300	695	750	735	785	785	580	1200	735	350	350	150	160	450	200	550
350	745	805	785	840	840	580	1200	785	400	400	175	165	500	220	600
400	795	861	835	895	895	630	1250	835	450	450	200	185	550	240	650
450	845	910	885	945	945	630	1250	885	500	500	225	205	600	260	700
500	895	965	935	998	998	680	1300	935	550	550	250	225	650	280	750
600						730	1350				300				
800						830	1450				400				
1000						930	1550				500				
1200						1130	1650				600				
1500						1230	1750				700				
1800						1330	1850				800				
2000						1430	1950				900				

Chapter 5 Model Selection

5.1 LUGB-B Model and function selection

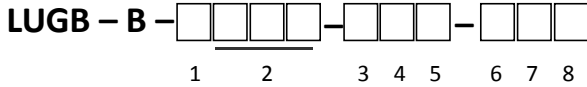

LUGB-B.....Pipeline-version Vortex flow meter

1. Measurable medium

- Y. Liquid;
- Q. Gas;
- Z. Steam;

2. Diameters of LUGB-B Vortex flow meter

No.	Diameters	No.	Diameters
015	DN15	080	DN80
020	DN20	100	DN100
025	DN25	125	DN125
032	DN32	150	DN150
040	DN40	200	DN200
050	DN50	250	DN250
065	DN65	300	DN300

3. LUGB-B Pipelined vortex flow meter connection amplifier

- K. Wafer Connection (Priority);
- F. Flange Connection;

4. Measurable high temperature medium

- D. -40°C...+260°C;
- G. -40°C...+300°C;

5. Compensation method

- N. No compensation
- T. Temperature compensation (limited to flange connection type DN25 and above);
- P. Pressure compensation (Limited flange connection type DN25 and above);

R. Temperature and pressure compensation (limited flange connection type DN25 and above);

6. Amplifier display

N. No display;

X. On-site display type (Note: The factory default fluid flow direction is from left to right. If there is any inconsistency on site, please indicate when ordering);

7. Output signal

P. Voltage pulse signal;

C. 4-20mA current signal;

N. No output signal;

8. Communication method

N. No communication;

R. RS485 communication;

5.2 LUGB-B vortex flow meter measurable liquid of different density corresponding with flow range under working condition

Item	500	600	700	800	900	1000	1200	1400	1600	1800	Qmax m3/h
mm	Qmin m3/h										Qmax m3/h
15	0.7	0.5	0.5	0.4	0.4	0.4	0.3	0.3	0.3	0.3	3.2
20	1.3	1.1	1.1	1.0	0.9	0.7	0.7	0.6	0.6	0.6	5.7
25	1.5	1.4	1.3	1.2	1.2	1.1	1.0	0.9	0.8	0.8	8.8
32	2.0	1.9	1.8	1.7	1.7	1.6	1.5	1.4	1.3	1.1	19
40	3.8	3.5	3.3	3.1	2.8	2.5	2.4	2.3	2.2	2.1	29
50	5.2	4.8	4.3	4.1	4.0	3.9	3.3	3.1	2.9	2.8	46
65	7.8	7.1	6.9	6.8	6.7	6.6	5.5	4.9	4.6	4.4	78
80	12.2	11.1	10.6	10.2	10.1	9.9	8.8	8.4	7.7	6.6	118
100	22	20	19	18	17	16	14	13	11	10	184
125	31	29	28	26	25	24	23	22	20	15	287
150	57	55	49	46	39	35	33	31	28	22	413
200	108	96	85	76	68	62	58	55	47	38	735
250	201	180	164	142	120	97	87	79	74	60	1148
300	273	240	219	197	175	140	131	120	107	84	1653

LUGB-B Vortex flow meter measure gas of different density corresponding with flow range under working condition

Item	0.5	0.8	1.2	2.4	3.6	4.8	6	7.2	8.4	9.6	12	20	Qmax m3/h
mm	Qmin m3/h												
15	6.7	4.8	3.8	3.6	3.3	3.1	2.9	2.6	2.4	2.1	1.9	1.7	32
20	10.2	7.4	6.8	5.9	5.7	5.5	5.3	5.1	4.9	4.7	4.5	4.2	57
25	17.4	14.0	10.6	10.2	10.0	9.5	9.1	8.5	8.3	8.1	7.8	6.4	88
32	22.0	19.8	17.4	16.7	15.8	15.2	14.5	13.6	13.0	11.9	11.0	9.9	188
40	50	35	27	26	25	24	23	23	22	21	20	17	294
50	81	53	42	40	38	36	34	32	30	28	25	21	459
65	111	92	72	67	65	60	53	51	49	46	42	28	776
80	164	135	109	92	90	86	82	78	72	61	53	37	1176
100	276	212	170	161	148	140	131	123	106	97	81	59	1837
125	397	353	265	243	221	199	177	155	137	124	106	77	2870
150	562	502	382	341	313	291	271	241	201	181	153	110	4133
200	920	751	678	630	581	533	484	436	388	339	266	206	7348
250	1696	1272	1060	1017	911	848	805	763	699	636	572	424	11481
300	1932	1700	1526	1410	1314	1198	1140	1004	927	811	773	580	16532

LUGB-B Vortex flow meter measure saturated steam of different density
corresponding with flow range under working condition

MPa		0.10	0.20	0.30	0.40	0.50	0.60	0.80	0.90	1.00	1.20	1.60	2.00
°C		120	134	144	152	159	165	175	180	184	192	204	215
Kg/m3		1.12	1.67	2.19	2.68	3.18	3.67	4.62	5.16	5.63	6.67	8.52	10.57
mm	Range	Different steam density corresponding with its measurable flow range											
15	Qmin	4.49	6.22	7.92	9.44	10.9	12.2	14.5	15.6	16.5	18.2	20.1	21.7
	Qmax	35.6	53.1	69.6	85.2	101	117	147	164	179	212	271	336
20	Qmin	7.74	10.8	13.3	15.8	18.4	21.0	25.6	28.1	30.2	34.6	41.4	48.4
	Qmax	63.3	94.4	124	151	180	207	261	292	318	377	482	597
25	Qmin	12.6	17.4	22.4	27.1	31.9	36.5	44.4	48.6	52.0	58.4	70.2	84.2
	Qmax	98.9	147	193	237	281	324	408	456	497	589	752	933
32	Qmin	20.0	28.6	36.8	44.2	51.3	57.9	70.5	77.2	82.8	93.5	110	122
	Qmax	211	314	412	504	598	690	869	971	1059	1255	1603	1988
40	Qmin	32.1	44.3	56.6	68.1	79.7	90.8	110	121	132	153	184	217
	Qmax	329	491	644	788	935	1079	1358	1517	1655	1960	2504	3107
50	Qmin	49.9	69.4	89.0	107	124	140	168	183	195	218	251	282
	Qmax	514	767	1006	1231	1460	1685	2122	2370	2585	3063	3913	4854
65	Qmin	84.9	117	149	178	208	236	281	299	311	346	412	469
	Qmax	869	1296	1700	2080	2468	2848	3586	4005	4369	5177	6612	8203
80	Qmin	128	171	208	246	289	330	400	437	468	531	602	614
	Qmax	1317	1963	2575	3151	3738	4315	5431	6066	6619	7841	10016	12426
100	Qmin	0.20	0.28	0.36	0.42	0.49	0.54	0.65	0.71	0.75	0.84	0.90	0.96
	Qmax	2.06	3.07	4.02	4.92	5.84	6.74	8.49	9.48	10.3	12.3	15.7	19.4
125	Qmin	0.32	0.43	0.54	0.64	0.73	0.81	0.93	0.99	1.03	1.10	1.15	1.23
	Qmax	3.21	4.79	6.29	7.69	9.13	10.5	13.3	14.8	16.2	19.1	24.5	30.3
150	Qmin	0.45	0.61	0.76	0.90	1.03	1.14	1.36	1.47	1.56	1.70	1.69	1.79
	Qmax	4.63	6.90	9.05	11.1	13.1	15.2	19.1	21.3	23.3	27.6	35.2	43.7
200	Qmin	0.78	1.10	1.40	1.66	1.90	2.12	2.50	2.67	2.81	3.05	3.26	3.27
	Qmax	8.23	12.3	16.1	19.7	23.4	27.0	33.9	37.9	41.4	49.0	62.6	77.7
250	Qmin	1.23	1.74	2.24	2.66	3.02	3.33	3.96	4.31	4.61	5.21	5.91	6.45
	Qmax	12.9	19.2	25.1	30.8	36.5	42.1	53.0	59.2	64.6	76.6	97.8	121
300	Qmin	1.75	2.47	3.13	3.72	4.28	4.80	5.61	6.09	6.52	7.10	7.80	8.41
	Qmax	18.5	27.6	36.2	44.3	52.6	60.7	76.4	85.3	93.1	110	141	175

Kg/h

t/h

5.3 LUGB-A Model and function selection

LUGB - - - -
 A B C D E F G H I J K L M N Q

LUCB - - - -
 P B O D E F G H I J R M N Q

LUGB-A.....Pipeline-version Vortex flow meter

LUCB-A.....Insertion-version Vortex flow meter

A. LUGB-A Pipelined vortex flow meter connection amplifier

1. Flange Connection (P/T compensation required);
2. Wafer Connection (Priority);

B. Measurable medium

1. Gas, Liquid, Steam-(Digital Filtering Intelligent Display);
2. Liquid;
3. Gas;
4. Saturated steam & superheated steam;

C、 Diameters of A type Vortex flow meter table 3

LUGB-A Pipeline-version		LUCB-A Insertion-version	
C	Diameter	O	Diameter
0+	10mm	020	200mm
00	15mm	025	250mm
01	20mm	030	300mm
02	25mm	035	350mm
03	32mm	040	400mm
04	40mm	045	450mm
05	50mm	050	500mm
06	65mm	060	600mm
08	80mm	070	700mm
10	100mm	080	800mm
12	125mm	085	850mm
15	150mm	090	900mm
20	200mm	100	1000mm
25	250mm	150	1500mm
30	300mm	160	1600mm
35	350mm	170	1700mm
40	400mm	180	1800mm
45	450mm	190	1900mm
50	500mm	200	2000mm

D、 Signal output

0. voltage pulse (lower $PWL \leq 1V$, higher $PWL \geq 6V$, pulse $\geq 10\mu S$);
1. two-wire 4~20mA;
2. without signal output and status display (flowrate, totalizer);
3. pulse equivalent (intelligent amplifier priority);
4. three-wire 4~20mA;
5. other;

E、 Measurable high temperature medium

0. $-40^{\circ}C \dots +150^{\circ}C$;
1. $-40^{\circ}C \dots +280^{\circ}C$ (LUCB mode $200^{\circ}C$) ;
2. $-40^{\circ}C \dots +350^{\circ}C$ (mismatching LUCB insertion-version) ;
3. $-40^{\circ}C \dots +420^{\circ}C$ (optional) ;

F. Amplifier display version

0. without status display;
1. status display (note: factory settings of fluid flow direction is from left to right, if special requirement, please advise manufacturer in advance.);

H. Accuracy

0. 1.0% (Priority for LUGB)
1. 0.5% (LUGB only)
2. 0.2% (LUGB only, optional)
3. 2.5% (priority for LUCB)
4. 1.5% (LUCB optional);

I. Amplifier installation

0. Integration between transmitter and sensor (compact version);
1. Amplifier separate from sensor (remote distance $\leq 10m$, mismatching vortex flow meter with compensation);
1. Submersible version;

J. Amplifier power supply

0. 12VDC ;
1. 24VDC (Digital filtering type required);
2. 3.6V Li Battery (LCD screen without signal output only);
3. 3.6V & 24VDC (LCD screen with signal output only);

K. Measuring Functions & amplifier display version

0. without compensation (w/o T/P compensation function);
 1. status display / gas temperature & pressure compensation / intelligent amplifier compact version (intelligent amplifier only with flange connection) (matching either 4-20mA output or voltage pulse output, pulse lower $PWL \leq 1V$, higher $PWL \geq 6V$, pulse duty-factor 50%);
 2. Status display / superheated steam temperature & pressure compensation / intelligent amplifier compact version (intelligent amplifier only with flange connection) (superheated steam and saturated steam expert) (density for compensation calculation and display mass flow) (matching either 4-20mA output or voltage pulse output, pulse lower $PWL \leq 1V$, higher $PWL \geq 6V$, pulse duty-factor 50%);
 3. Status display with temperature compensation (intelligent amplifier only with flange connection or wafer connection) (saturated steam expert) (via temperature and do density compensation calculation display mass flow) (matching either 4-20mA output or voltage pulse output, pulse lower $PWL \leq 1V$, higher $PWL \geq 6V$, pulse duty-factor 50%);
 4. Status display with pressure compensation (intelligent amplifier only with flange connection or wafer connection) (saturated steam expert) (via pressure and do density compensation calculation display mass flow) (matching either 4-20mA output or voltage pulse output, pulse lower $PWL \leq 1V$, higher $PWL \geq 6V$, pulse duty-factor 50%);
- L. LUGB-A Pipeline-version Vortex flow meter Sensor Head**

Installation

0. stop medium flow to dismantle sensor head;
1. keep medium flow to dismantle sensor head (medium temp $\geq 350^{\circ}C$ is required);

M. Communication

0. without communication
1. RS485 (intelligent amplifier only)
2. RS232 (intelligent amplifier only);

N. HART protocol

0. without HART protocol;
1. with HART protocol (optional);

- 0. stop medium flow to dismantle
- 1. keep medium flow to dismantle

Q. The mode of wave filtering

- 0. common mode
- 1. Intelligent Digital filtering mode;

R. LUCB Insertion-version Vortex flanges pressure class

- 1. PN1.6Mpa (priority)
- 2. PN2.5MPa (pressure>2.5 MPa optional);
- 3. Attention: integrated P/T compensation Compact vortex apply in steam measurement, if designing drainage receiver configuration. Then Horizontal Installation is required. If vertical installation or leaning installation condensing drainage loop receiver is required.

5.4 LUGB-A pipeline-version vortex flow meter measurable flow range (refer to table.4~7)

Notes : when choose vortex flow meter that keep medium flow with dismountable sensor head or vortex flow meter with accuracy is $\pm 0.5\%$, the lower limit of flow range is 1.5 times of corresponding value from table 4~7, upper limit multiplied by 0.8

LUGB-A vortex flow meter measurable liquid of different density corresponding with flow range under working condition table 4

ITEM	500	600	700	800	900	1000	1200	1400	1600	1800	Qmax (m ³ /h)
	kg/m ³	kg/m ³	kg/m ³	kg/m ³	kg/m ³	kg/m ³	kg/m ³	kg/m ³	kg/m ³	kg/m ³	
Different density of liquid matching its measurable lower imit flow Q-min (unit:m 3 /h)											
DN10	0.30	0.28	0.24	0.21	0.19	0.15	0.14	0.13	0.12	0.11	2.0
DN15	0.60	0.50	0.47	0.37	0.36	0.35	0.30	0.28	0.26	0.24	4.5
DN20	1.15	1.00	0.98	0.90	0.80	0.60	0.58	0.56	0.54	0.52	8.0
DN25	1.30	1.20	1.10	1.05	1.00	0.90	0.82	0.76	0.71	0.68	12
DN32	1.90	1.80	1.70	1.62	1.56	1.50	1.45	1.35	1.20	1.00	20
DN40	3.50	3.20	3.00	2.80	2.60	2.28	2.20	2.10	2.00	1.90	32
DN50	4.70	4.30	3.9	3.70	3.60	3.50	3.00	2.80	2.60	2.50	50
DN65	7.10	6.50	6.30	6.20	6.10	6.00	5.00	4.50	4.20	4.00	84
DN80	11	10	9.60	9.20	9.10	9.00	8.00	7.60	7.00	6.00	127
DN100	20	18	17	16	15	14	13	12	10	9.00	198
DN125	28	26	25	24	23	22	21	20	18	14	310
DN150	52	50	45	42	36	32	30	28	26	20	445
DN200	99	88	78	70	62	57	53	50	43	35	791
DN250	184	165	150	130	110	89	80	72	68	55	1237

Chapter 5 Model Selection

DN300	250	220	200	180	160	128	120	110	98	77	1780
DN350	350	280	250	210	190	173	160	140	120	100	2450
DN400	450	400	360	300	260	226	200	180	160	140	3160
DN450	500	450	400	350	300	286	260	240	210	180	4000
DN500	600	530	480	420	380	355	330	300	260	220	4950

LUGB-A Vortex flow meter measure gas of different density corresponding with flow range under standard condition table 5

ITEM	0.50	0.80	1.20	2.40	3.60	4.80	6.00	7.20	8.40	9.60	12.0	20	Q _{max} (m ³ /h)
	kg/m ³	kg/m ³	kg/m ³	kg/m ³	kg/m ³	kg/m ³	kg/m ³	kg/m ³	kg/m ³	kg/m ³	kg/m ³	kg/m ³	
Different gas density under standard condition, lower limit Q-min (unit: m ³ /h)													
DN10	2.8	2.0	1.6	1.5	1.4	1.3	1.2	1.1	1.0	0.9	0.8	0.7	16
DN15	4.8	3.5	3.2	2.8	2.7	2.6	2.5	2.4	2.3	2.2	2.1	2.0	38
DN20	8.2	6.6	5.0	4.8	4.7	4.5	4.3	4.0	3.9	3.8	3.7	3.0	67
DN25	10	9	7.9	7.6	7.2	6.9	6.6	6.2	5.9	5.4	5.0	4.5	100
DN32	26	18	14	13.2	12.8	12.2	12	11.7	11.2	10.9	10.1	9	170
DN40	38	25	20	19	18	17	16	15	14	13	12	10	300
DN50	48	40	31	29	28	26	23	22	21	20	18	12	500
DN65	80	66	53	45	44	42	40	38	35	30	26	18	780
DN80	130	100	80	76	70	66	62	58	50	46	38	28	1200
DN100	180	160	120	110	100	90	80	70	62	56	48	35	2000
DN125	280	250	190	170	156	145	135	120	100	90	76	55	2900
DN150	380	310	280	260	240	220	200	180	160	140	110	85	4100
DN200	800	600	500	480	430	400	380	360	330	300	270	200	7500
DN250	1000	880	790	730	680	620	590	520	480	420	400	300	12500
DN300	1300	1190	1140	1060	980	900	820	760	700	620	580	400	16500
DN350	1800	1600	1550	1400	1300	1200	1100	1000	900	820	720	600	22000
DN400	2200	2160	2000	1800	1650	1500	1400	1300	1200	1100	1000	700	30000
DN450	2700	2580	2500	2300	2100	1900	1700	1600	1500	1400	1200	800	37000
DN500	3500	3200	3100	2900	2600	2400	2200	2000	1800	1600	1300	1000	46000

Conversion formula of gas volume flow under working condition & volume flow under standard condition:

$$Q_w = Q_s \cdot P_s \cdot Z \cdot (273.15 + T_w) / [(P_w + P_L) \cdot (273.15 + T_s)] \text{---FORMULA 4}$$

Among formula :

Q_w --- volume flow under working condition (unit: m³/h)

P_w --- gas pressure under working condition (unit: Mpa)

T_w --- gas temperature under working condition (unit: °C)

Z ---- gas relative compressibility Z=Z_w/Z_s (zero dimension)

Q_s --- volume flow under standard condition (unit: m³/h)

P_s --- Atm press under standard condition (take absolute pressure =0.101325

MPa)

T_S --- temperature under standard condition (0°C or 20°C)P_L -- local Atm press (unit: MPa)

LUGB-A Vortex flow meter measure saturated steam of different density
corresponding with flow range under working condition table 6

MPa	0.10	0.20	0.30	0.40	0.50	0.60	0.80	0.90	1.00	1.20	1.60	2.00	
°C	120	134	144	152	159	165	175	180	184	192	204	215	
Kg/m ³	1.12	1.67	2.19	2.68	3.18	3.67	4.62	5.16	5.63	6.67	8.52	10.57	
mm	Range	Different steam density corresponding with its measurable flow range											
10	Qmin	1.55	2.28	2.99	3.68	4.46	5.10	6.48	7.27	7.82	9.11	11.8	14.6
	Qmax	15.5	22.9	30.0	36.9	44.6	51.0	64.8	72.8	78.2	91.1	119	146
15	Qmin	3.50	5.15	6.74	8.29	10.0	11.4	14.5	16.3	17.6	20.5	26.7	32.9
	Qmax	35.0	51.5	67.4	83.0	100	115	146	163	176	205	268	329
20	Qmin	6.22	9.15	11.9	14.7	17.8	20.4	25.9	29.1	31.3	36.4	47.5	58.5
	Qmax	62.2	91.6	120	147	178	204	259	291	313	365	476	586
25	Qmin	9.71	14.3	18.6	23.0	27.9	31.8	40.5	45.4	48.9	56.9	74.3	91.4
	Qmax	97.1	143	187	230	279	318	405	454	489	569	743	914
32	Qmin	15.9	23.3	30.6	37.7	45.7	52.2	66.3	74.5	80.1	93.3	121	149
	Qmax	159	234	306	378	457	522	664	745	802	933	1218	1499
40	Qmin	23	33	43	53	64	73	93	100	110	130	170	210
	Qmax	300	440	575	710	860	980	1250	1400	1500	1750	2280	2810
50	Qmin	35	35	52	63	76	88	111	125	130	150	200	250
	Qmax	550	460	680	845	1020	1170	1480	1670	1800	2100	2730	3360
65	Qmin	59	87	114	137	166	190	240	276	297	345	450	550
	Qmax	790	1160	1520	1835	2222	2540	3230	3620	3970	4620	6030	7422
80	Qmin	89.5	131	172	212	257	290	370	410	450	520	680	840
	Qmax	1195	1760	2300	2800	3400	3900	4900	5580	6000	6999	9100	11000
100	Qmin	0.14	0.20	0.27	0.33	0.40	0.46	0.58	0.65	0.70	0.82	1.00	1.30
	Qmax	1.87	2.75	3.60	4.43	5.36	6.12	7.78	8.73	9.40	11	14.3	17.6
125	Qmin	0.22	0.32	0.42	0.51	0.62	0.71	0.91	1.00	1.10	1.28	1.67	2.00
	Qmax	2.91	4.29	5.62	6.91	8.37	9.56	12	13.6	14.7	17	22.3	27.4
150	Qmin	0.32	0.46	0.60	0.74	0.90	1.03	1.31	1.47	1.58	1.84	2.40	2.96
	Qmax	4.20	6.18	8.09	9.96	12	13.8	17.5	19.6	21.1	24.6	32.1	39.5
200	Qmin	0.56	0.82	1.08	1.32	1.60	1.83	2.33	2.61	2.81	3.28	4.28	5.27
	Qmax	7.50	11	14.4	17.7	21.4	24.5	31.1	35	37.6	43.7	57.1	70.3
250	Qmin	0.87	1.28	1.68	2.0	2.51	2.87	3.64	4.09	4.40	5.10	6.69	8.20
	Qmax	11.6	17	22	27.6	33	38	48	54	58.7	68	89	110
300	Qmin	1.25	1.85	2.42	2.98	3.61	4.13	5.25	5.89	6.34	7.38	9.60	11.8
	Qmax	16.7	24.7	32	39	48	55	70	78	84	98	128	158
350	Qmin	1.71	2.52	3.30	4.06	4.92	5.62	7.15	8.02	8.60	10.0	13	16
	Qmax	22.8	33.6	44	54	65	74.9	95	106	115	133	174	215
400	Qmin	2.24	3.29	4.30	5.30	6.40	7.30	9.30	10.5	11.2	13.1	17	21
	Qmax	29	43.5	57	70	85	97	124	139	150	174	228	281
450	Qmin	2.83	4.17	5.45	6.72	8.13	9.29	11.8	13.2	14.2	16.6	21.6	26.6
	Qmax	37	56	72	89	108	123	157	176	190	221	289	355

Chapter 5 Model Selection

500	Qmin	3.49	5.15	6.74	8.29	12.3	14	17.9	20.1	21.6	25.2	33	40.5	
	Qmax	46	68	89.8	110	164	188	239	268	289	336	439	540	

Superheated steam table 7 (unit : kg/m³)

ITEM	130°C	140°C	150°C	160°C	170°C	180°C	190°C	210°C	220°C	250°C	300°C	360°C	420°C
0.10MP	1.10	1.07	1.04	1.02	0.99	0.97	0.95	0.91	0.89	0.83	0.76	0.69	0.63
0.15MP	1.38	1.34	1.34	1.28	1.24	1.21	1.19	1.13	1.11	1.04	0.95	0.86	0.78
0.26MP		1.96	1.90	1.85	1.81	1.76	1.72	1.64	1.61	1.51	1.37	1.24	1.13
0.30MP			2.12	2.067	2.01	1.96	1.92	1.83	1.79	1.68	1.53	1.38	1.26
0.36MP			2.46	2.39	2.33	2.27	2.21	2.11	2.06	1.94	1.76	1.59	1.45
0.40MP				2.61	2.54	2.47	2.41	2.30	2.25	2.11	1.91	1.73	1.57
0.50MP				3.16	3.07	2.99	2.91	2.77	2.71	2.54	2.30	2.07	1.89
0.60MP					3.61	3.51	3.42	3.25	3.18	2.97	2.69	2.42	2.21
0.70MP						4.05	3.94	3.74	3.65	3.41	3.09	2.78	2.53
0.80MP						4.59	4.46	4.23	4.13	3.85	3.48	3.13	2.84
0.90MP						5.15	4.99	4.73	4.61	4.30	3.88	3.48	3.16
1.00MP							5.54	5.23	5.09	4.75	4.28	3.84	3.48
1.15MP							6.37	6.00	5.84	5.43	4.88	4.37	3.97
1.50MP								7.87	7.64	7.05	6.30	5.63	5.10
1.65MP								8.70	8.43	7.76	6.92	6.17	5.59
1.80MP								9.55	9.24	8.48	7.55	6.72	6.08
2.00MP									10.36	9.47	8.39	7.45	6.74
2.20MP									11.51	10.47	9.24	8.20	7.40
2.50MP										12.02	10.55	9.32	8.39

Several normal gas of density under standard condition table 8 (unit : kg/m³)

Tag	Air	Hydrogen	Oxygen	Nitrogen	Chlorine	Ammonia gas	Semi-watergas
Density	1.293	0.0889	1.43	1.251	3.214	0.77	0.836
Tag	Argon	Acetylene	Methane	Ethane	Propane	Butane	Coke-oven gas
Density	1.79	1.017	0.717	1.357	2.005	2.703	0.4849
Tag	Ethylene	Propylene	Natural gas	Coal gas	CO	CO ₂	
Density	1.264	1.914	0.828	0.802	1.25	1.977	

Notes: standard state is absolute pressure 0.101325MPa and temperature 0°C.

5.5 LUCB-A insertion-version vortex flow meter measurable flow range under working condition and its calculation. See table 9

LUCB-A insertion-version vortex flow meter measure liquid of different density corresponding with flow range under working condition. table 9

Gas	Density $\rho(\text{kg/ m}^3)$	1.0	1.2	2.0	3.0	4.0	6.0	8.0	10	15	20	Vmax(m/s)
	Vmin(m/s)	5.5	5.2	5.0	4.8	4.6	4.2	4.0	3.8	3.6	3.5	55
Liquid	Density $\rho (\text{ kg/m}^3)$	500	600	700	800	900	1000	1200	1400	1600	1800	Vmax(m/s)
	Vmin(m/s)	0.96	0.8	0.70	0.66	0.62	0.60	0.56	0.52	0.50	0.45	6.0

Notes : table 9 that is accuracy $\pm 2.5\%$ of insertion-version vortex flow meter flow range. When accuracy is better than $\pm 2.5\%$, velocity of flow = lower limit of velocity multiplied by coefficient R(R=2-3), the upper limit multiplied by 0.8.

5.6 LUCB-A insertion-version vortex flow meter measurable medium flow range calculation under working condition.

Gas & liquid : min volume flow formula under working condition

$$Q_{\min} = 3600 \cdot V_{\min} \cdot (\pi \cdot D^2 / 4) \text{ ----- Formula 5}$$

Gas & liquid : max volume flow formula under working condition

$$Q_{\max} = 3600 \cdot V_{\max} \cdot (\pi \cdot D^2 / 4) \text{ ----- Formula 6}$$

Gas : min volume flow formula under standard condition

$$Q_{N\min} = Q_{\min} \cdot [(P_L + P_w) \cdot (273.15 + T_s)] / [P_s \cdot Z \cdot (273.15 + T_w)] \text{ ---- Formula 7}$$

Gas : max volume flow formula under standard condition

$$Q_{N\max} = Q_{\max} \cdot [(P_L + P_w) \cdot (273.15 + T_s)] / [P_s \cdot Z \cdot (273.15 + T_w)] \text{ ----- Formula 8}$$

Gas : density formula under working condition

$$\rho = \rho_n \cdot [(P_L + P_w) \cdot (273.15 + T_s)] / [P_s \cdot Z \cdot (273.15 + T_w)] \text{ ----- Formula 9}$$

Among (insertion-version vortex flow meter) :

Q_{\min} -- min volume flow under working condition (unit : m^3 / h)

Q_{\max} -- max volume flow under working condition (unit : m^3 / h)

V_{\min} -- min velocity under working condition (unit : m/s refer to fig.7)

V_{\max} -- max velocity under working condition (unit : m/s refer to fig.7)

D ----- nominal diameter of insertion-version vortex flow meter (unit : m)

π ----- circumference ratio 3.1415926535898

QNmin - gas min volume flow under standard condition (unit : m³ /h)

QNmax - gas max volume flow under standard condition (unit : m³ /h)

T_s --- temperature under standard condition, general is 0°C or 20°C. (unit:°C)

T_w --- measurable gas temperature under working condition (unit:°C)

P_s --- normal atmospheric pressure (=0.101325MPa)

P_w --- measurable gas pressure under working condition (unit : MPa)

Z ----- measurable fluid relative compressibility $Z=Z_w/Z_s$

ρ----- gas density under working condition (unit : kg/m³)

ρ_n ---- gas density under standard state (unit: kg/m³ ; temp is 0°C or 20°C, absolute pressure is 0.101325MPa , among formula 9 the temperature is the same between T_s and ρ_n corresponding temp. Several normal gas density under standard state see table 6)

P_L -- local atmospheric pressure (unit : MPa)

LUCB-A insertion-version vortex flow meter Numerical Methods of flow range matching steam measurement:

1. According to steam temperature and pressure refer to table 4 & table 5 then gain exact density "ρ" under working condition.
2. According to steam density "ρ" under working condition, refer to table 7 then gain max/min velocity of flow under working condition " Vmax/Vmin " .
3. According to pipe diameter of insertion-version vortex flow meter, through Formula 5 and Formula 6 calculate min volume under working condition or max volume.
4. The final density "ρ" under working condition x Qmin or Qmax = mass flow range .

Chapter 6 Installation Instruction

- Installation Place and Environment Selection
 1. Try to avoid strong power equipment, high-frequency equipment and strong power switchgear.
 2. Try to avoid high-temp thermal source and source of radiant heating; outdoor installation should do some measures of sun-shading and rain shelter.
 3. Try to avoid shock places and corrosion environment; meanwhile, easy maintenance should be considered.

- Reasonable and correct installation position.
 1. Installation position should avoid strong shock pipeline, or take some measures of shock absorption.
 2. Horizontal, vertical and slanting installation. Liquid measuring ensure flow direction from low to high. Gas measuring, direction no required. When measuring vapor or high-temp gas, flow meter body pillar should be at an angle of 45 Deg with vertical direction.

- Grounding requirement.

When pipelines without available grounding conditions, a ground-wire is essential between housing and earth.

- Required lengths of straight pipe

In order to correct measurement, upstream or downstream of flow meter should obligate enough straight length.

No components to effect fluid velocity in upstream of flow meter. All types of straight length installation reference:

Vortex flow meter required lengths of straight pipe fig.3

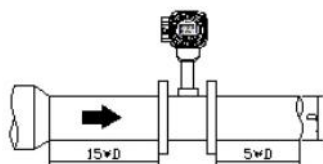

Swaged version

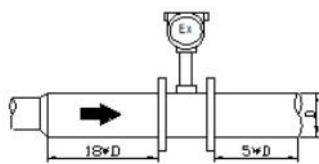

Enlarged diameter version

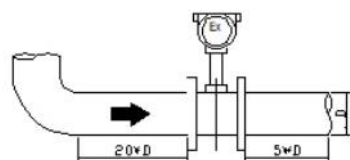

1*90° conduit elbow

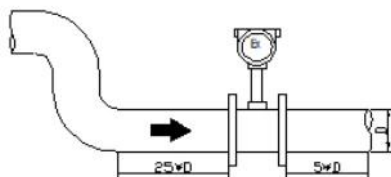

Isoplanar 2*90° conduit elbow

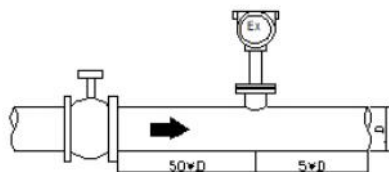

Shutoff valve

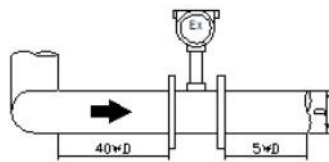

Noncoplanar 2*90° conduit elbow

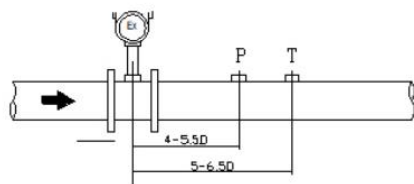

Position of temperature sensor and pressure sensor

Installation and welding of flow meter

LUGB Vortex diameter is accordant to upstream and downstream tubing diameter at installation point; sensor is concentric with pipeline; prohibit gaskets between sensor and flanges bulge out into pipeline. Make sure that the connection end face of insertion-version vortex flow meter parallel to the pipe axis. Details as per fig.4.

After initial installation, when medium is steam or other high-temp medium, flanges & bolts should be re-tightened when medium full of pipeline. Do heat reservation measures for pipeline in order to protect amplifier. Fig.4

SUP-LUGB-B model

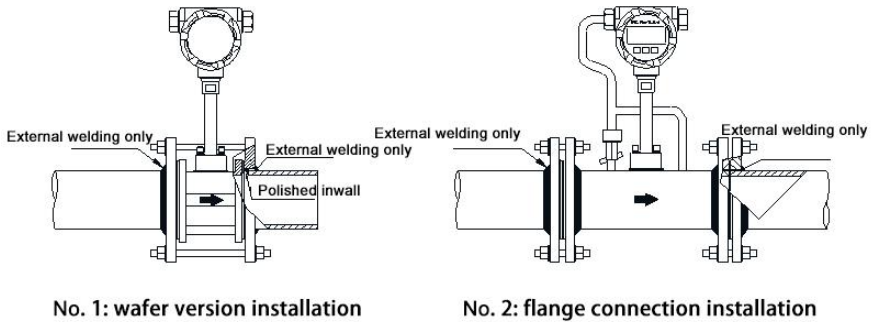

SUP-LUGB-A model

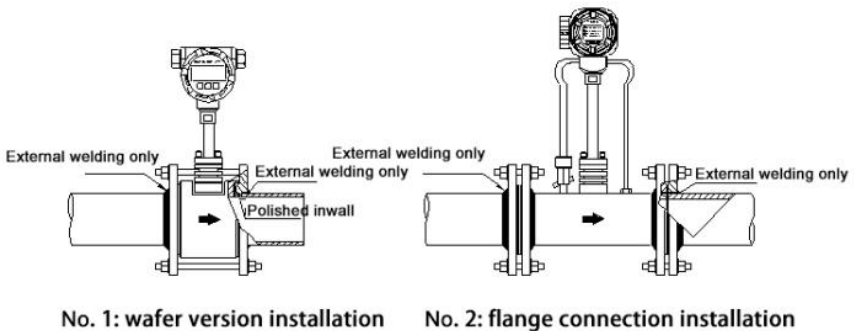

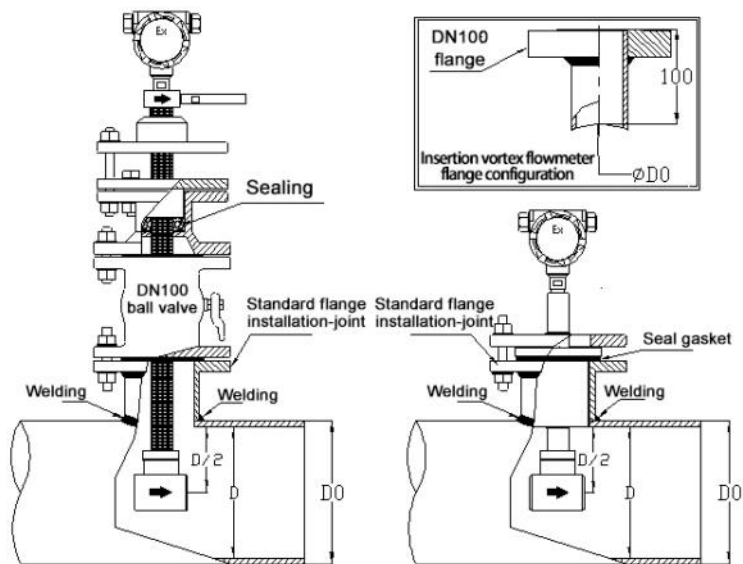

No. 3: LUCB insertion vortex flowmeter (disassembly and assembly under continuous flow condition)

No. 4: LUCB insertion vortex flowmeter (disassembly and assembly under cut off flow condition)

Be attention: concerning P/T compensation integrated vortex flow meter, to avoid high-temp or liner shock damage pressure transmitter, Pressure control valve must be closed before medium is full of pipeline. When medium full of pipeline meanwhile approaching working temperature and pressure, slowly turn on control valve. Pressure tapping and pressure detector should be done heat reservation if flow meter outdoor installation.

Chapter 7 Wiring

The connecting wire should select AVPV2*0.5mm² two-core or AVPV3*0.5mm² three-core shielded cable produced by the regular manufacturer. When the cable is connected with the terminal, it is needed to be ensure that the connection is reliable. When the amplifier housing is not grounded, the measurement will not be stable and accurate.

Note: The external power supply of the intelligent amplifier must be 24VDC±5%
The wire circuit resistance is ≤50Ω current output; if the wire loop resistance does not meet this requirement, the cable length or the cable cross sectional area should be considered to reduce the wire loop resistance.

The connection terminals of various amplifiers of vortex flow meters are described as follows:

A. Non-display pulse output type (three-wire voltage pulse) wiring

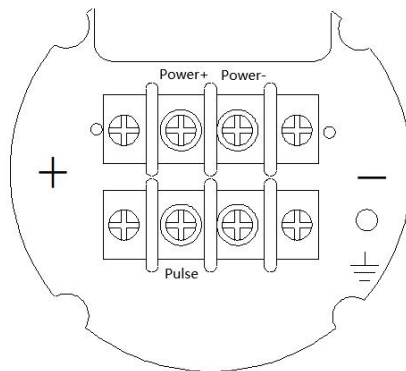

Power+: power supply 24/12VDC+	Note: When negative pole of the power supply and pulse input ground connection is not be shared,because the connections will be short-circuited.
Power-: power supply 24/12VDC-	
Pulse: pulse output	

B. Non-display current output type (two-wire 4-20mA) wiring

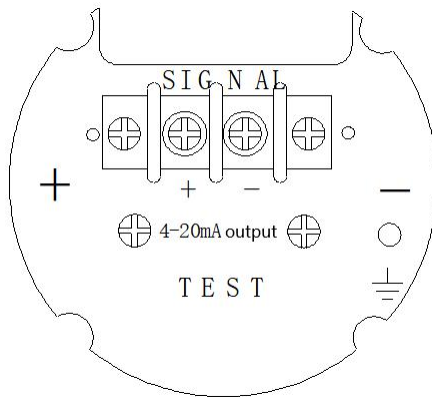

Power+: power supply 24VDC +	Note: K5 on the back circuit board is a short-circuit plug between the negative pole of the power supply and the ground. The factory default is the short-circuit state. When the external signal receiving system has a separate "ground", K5 needs to be disconnected, otherwise it will cause inaccurate measurement.
Power-: 4-20mA output	

C. On-site display without output type

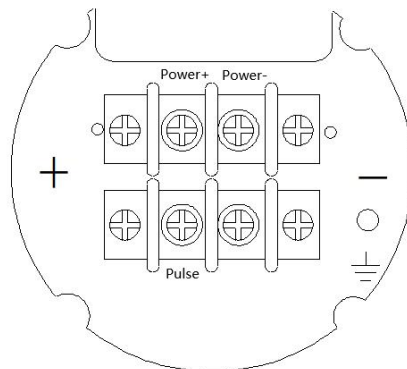

Power+: power supply 24VDC+	
Power-: power supply 24VDC-	

D. On-site display pulse output type (three-wire voltage pulse)

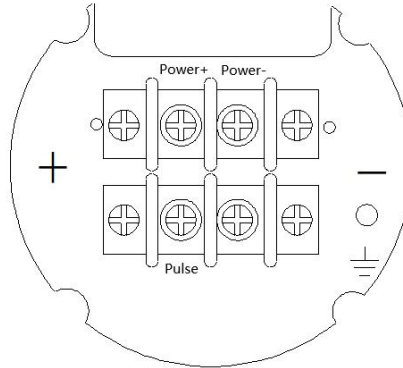

Power+: power supply 24VDC+	<p>Note: When the negative pole of the external power supply and negative pole of the pulse input do not share "ground", they should be short-circuited. This type of amplifier always requires battery power to work properly, so after the external power supply is turned on, you still need to turn the battery switch to the "ON" position to use it normally.</p>
Power-: power supply 24VDC-	
Pulse: pulse output	

E. On-site display current output type (two-wire system 4-20mA)

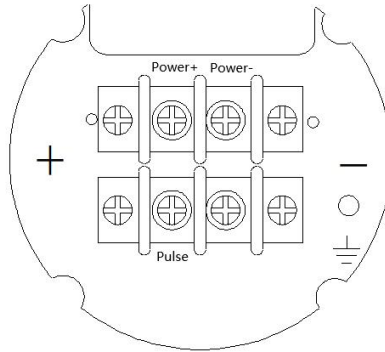

Power+: power supply 24VDC+	<p>Note: When the external signal receiving system has a separate "ground", the "pulse (secondary meter)" plug on the back circuit board needs to be disconnected, otherwise the measurement will be inaccurate. This type of amplifier always requires battery power to work properly, so after the external power supply is turned on, you still need to turn the battery switch to the "ON" position to use it normally.</p>
Power-: 4-20mA output	

F. Digital filter type wiring (First edition) wiring

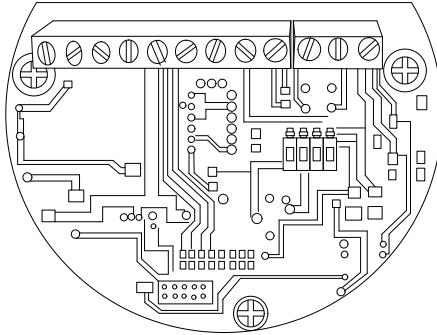

V+	power supply 24VDC+	Note: When the current is output, the terminals 1 and 2 of the switch K should be set to the ON position, and the terminals 3 and 4 should be set to the OFF position; when the pulse is output, the terminal 3 of the switch K should be set to the ON position , Terminals 1, 2, and 4 are set to the OFF position.
F	pulse output	
V-	pulse output: 24VDC- and pulse-; 4-20mA output: 4-20mA+	
A、B	A:RS485+、 B:RS485-	

Note: Switch 4 is a short-circuit switch between the input power ground and the shell ground, and it should be in the OFF position under normal circumstances.

G. Digital filter type wiring (Second edition) wiring

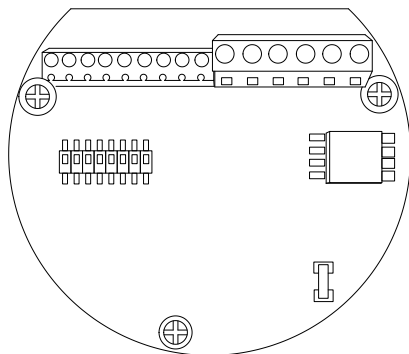

V+	power supply 24VDC+	<p>Note: When the two-wire current is output, the terminals 1 and 2 of the switch K should be set to the ON position, and the terminals 3, 4, 5, 6, 7, 8 should be set to the OFF position; when the power supply negative When "ground", 5 should be set to ON position; when frequency output or three-wire current output, the 4, 5, 6, 7 terminals of switch K should be set to ON, and 1, 2 terminals should be set to OFF. When RS485 communication, set the terminal 8 of switch K to the ON position.</p>
I	three-wire 4-20mA+	
F	pulse output	
V-	pulse output and three-wire 4-20mA : 24VDC- and pulse-; two-wire 4-20mA output: 4-20mA+	
A, B	A:RS485+, B:RS485-	

Note: The terminal board switch 5 is a short-circuit switch between the "power-" and the housing. When the signal-receiving end "power-" is not grounded, it must be opened to ground the "power-" (such as a secondary instrument) ; When the signal receiving terminal "power -" is grounded, it needs to be turned off (such as DCS).

H. Smart battery powered type wiring

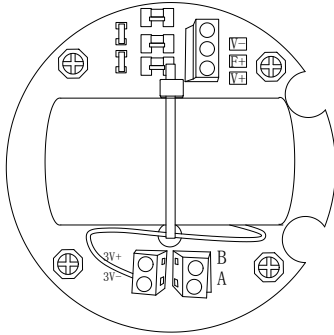

V+	Power supply 24VDC+	Note: This instrument has the function of automatic switching between 3.6V lithium battery and 24VDC. When only 3.6V lithium battery is needed for power supply, the battery switch is set to the "ON" position for normal use.
F	Pulse output	
V-	Pulse output: 24VDC- and pulse-; two-wire 4-20mA output: 4-20mA+	
A, B	A:RS485+, B:RS485-	

Note:

- 1) When inserting or removing the LCD and daily use of the above several amplifiers, do not press the LCD cable forcefully to prevent it from being broken and damaged;
- 2) T+, T-, T- are PT100 thermal resistance terminals; PV-, PV+, PI-, PI+ are pressure sensor terminals;

Chapter 8 Interface Display

8.1 Main display

(1) Main display

- Digital filter type (First edition)

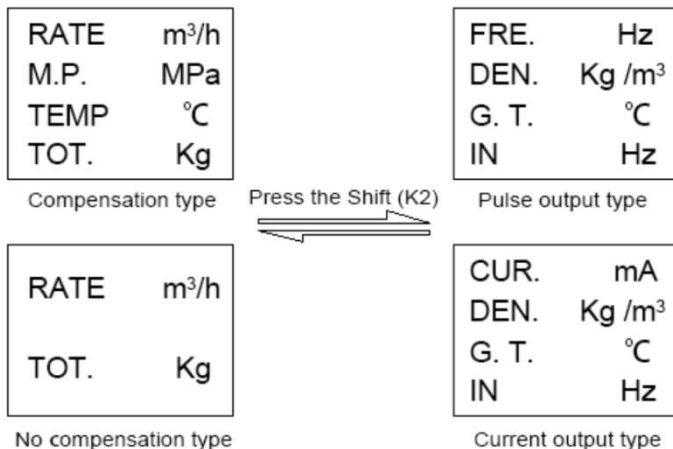

- **Digital filter type (Second edition)**

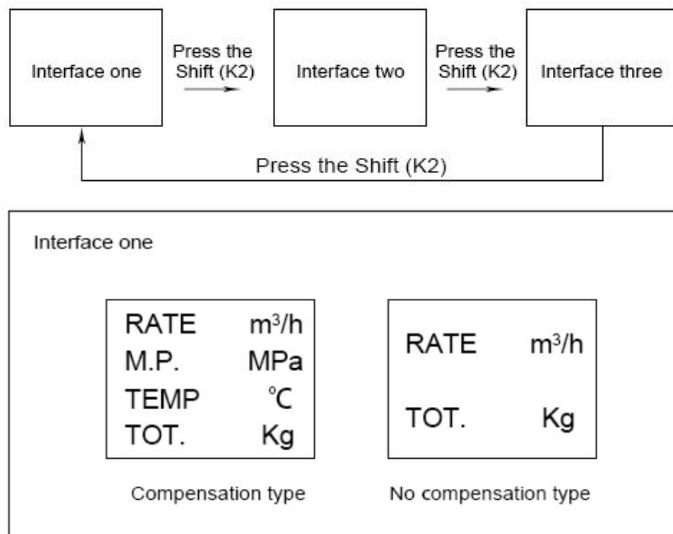

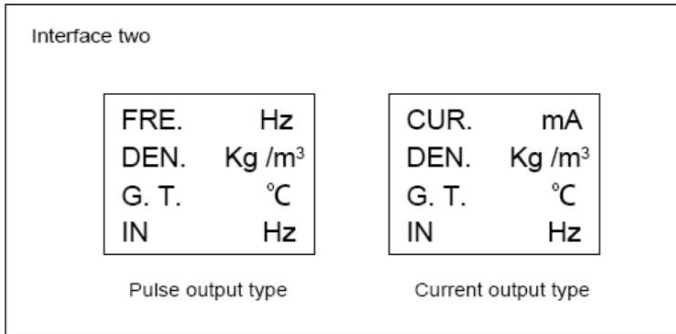

- **Battery-powered type**

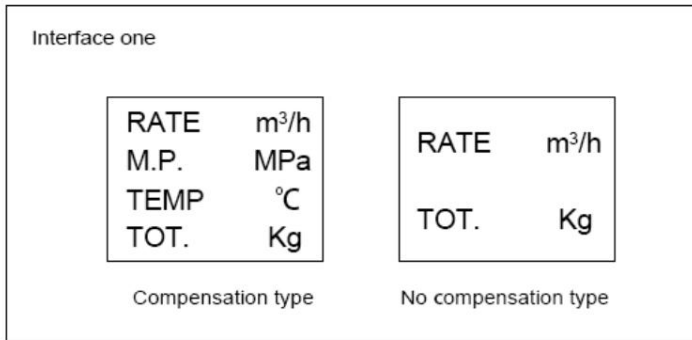
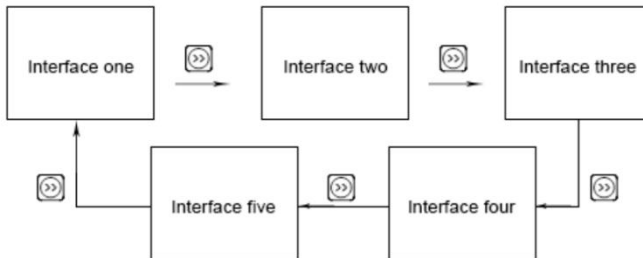

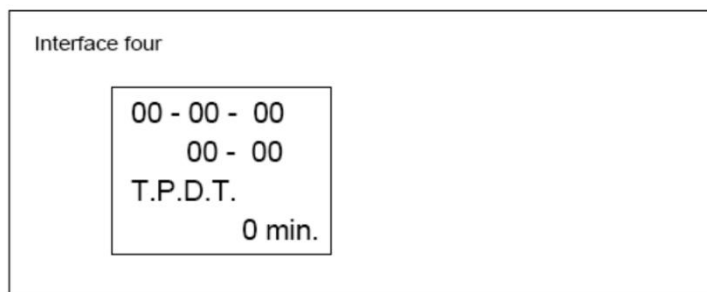
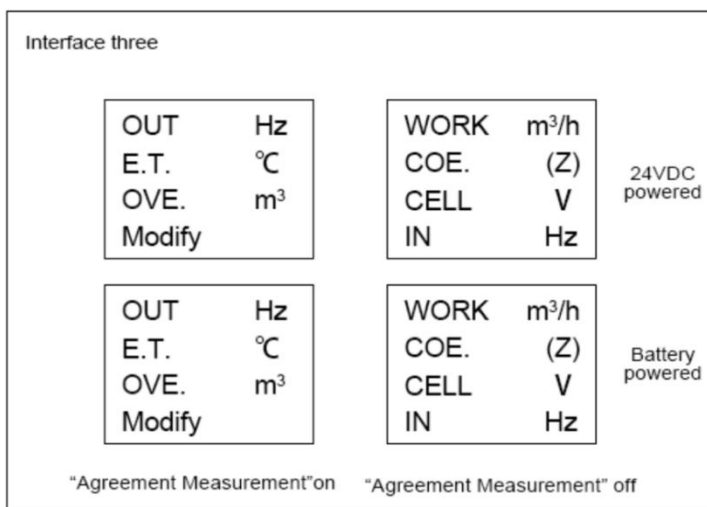
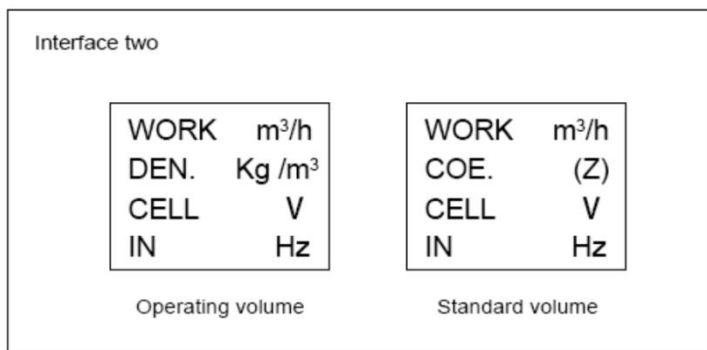

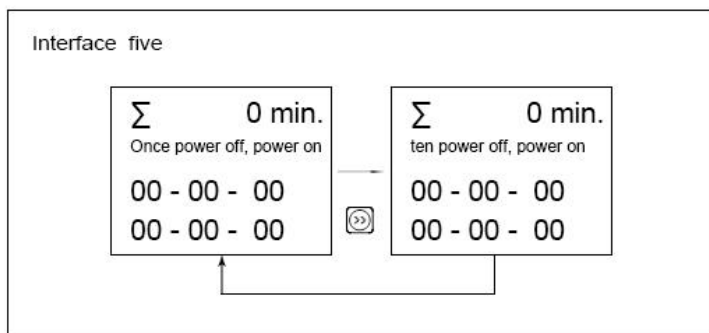

Note: Interface display instructions (marked ◇ Unique features of the first edition of digital filter type, annotations ☆ Unique features of the second edition of digital filter type, annotations ※ Unique features of battery powered type)

1. Instantaneous / cumulative display range:
 - Instantaneous flow display range 0.0-99999999;
 - Cumulative flow display range 0.0-99999999 (battery powered type cumulative flow display range 0.0-999999999) ;
 - a) The "instantaneous" flow unit can be set through the menu, the "cumulative" flow unit the same as the instantaneous flow unit;
 - b) When the cumulative amount accumulates to 100000000 (accumulated to 1000000000 by battery-powered type), all will be cleared and re-accumulated;
 - c) When the flow unit is changed, the accumulated flow value still keeps the original value. At this time, please record the original accumulated amount, then reset it to zero, and re-accumulate.

2. Temperature, pressure display range:
 - Temperature display range -50.0—+430.0℃;
 - Pressure display range -0.10—+20.0MPa;
 - A. In manual compensation mode, if the upper and lower limits of temperature and pressure are set to the same value, the "temperature" and "pressure" on the interface will display the set fixed values;

- B. Automatic compensation mode:
 - a) In the "temperature and pressure compensation" mode, the temperature and pressure display values are actual measured values;
 - b) In "saturated steam temperature compensation" mode, the temperature is the actual measured value, and the pressure is calculated by the software;
 - c) In "saturated steam pressure compensation" mode, the pressure is the actual measured value, and the temperature is calculated by the software;

- 3. "Frequency", "Current": display the corresponding frequency or current output value according to the setting of "Output Type" in the menu:
 - A. "Working condition pulse" mode: display the corresponding working condition pulse frequency value, display range: 0.0-9999.9Hz;
 - B. "Standard pulse" mode: display the corresponding standard pulse frequency value, display range: 0.0-9000.0Hz;
 - C. "Current" mode: display the current value corresponding to the upper and lower limits of the flow rate, display range: 4.00-20.80mA;
 - D. ※ "Current percentage" mode: display the flow percentage corresponding to the upper and lower limits of the output, display range: 0.00-105.00%;

- 4. "Density": display range: 0.000-99999999kg/m³
 - A. When the "flow unit" is set to mass flow (ie kg/h, t/h, etc.), the "density" item in the second interface displays the density of the measured medium;
 - B. When the "flow unit" is set to volume flow (ie m³/h, km³/h, etc.), the "density" item is displayed as NULL (the first version of digital filter type is displayed as "-");

- 5. "Amplifier temperature": The "amplifier temperature" item in the second interface displays the internal temperature of the amplifier housing, and the display range: -99.9-+99.9℃;
"Input": The "input" item in the second interface displays the actual measured frequency value of the sensor, and the display range: 0.0-9999.9Hz;

- 6. ※"Working condition": display instantaneous working condition volume flow, display range: 0.000-99999999m³/h;





7. *Coefficient*: When the "flow unit" is set to the standard condition volume flow (ie Nm³/h, etc.), the medium working condition compression factor is displayed, and the display range: 0.000000-9.999999;
8. *Battery*: Display battery voltage, display range 0.00-9.99V, when battery voltage is lower than 3.2V, display 
9. *Overrun*: When the "protocol measurement" function is on, the cumulative flow exceeding the upper limit is displayed, display range: 0.000-999999999. The "overrun" flow unit is the same as the "cumulative" flow unit;
Note: When the over-limit flow accumulates to 1000000000, all will be cleared and re-accumulated.
10. **Menu modification*: display the number of menu modification, display range 0-9999, when added to 10000, clear and re-record;
11. * System clock display: displays the current time, the total number of minutes of power down, and displays when the "system clock" is on;
12. * Incoming power outage record: can save the time of the last 10 outages; display when "system clock" is on;
Description of power failure time interface:
 - A. The first line: total power-off time, display range 0-999999999 minutes;
 - B. The second line: display the time sequence, "first power-off, power-on" is the last time, "second power-off, power-on" is the last time, and so on;
 - C. The third line: display the power outage time of this time;
 - D. The fourth line: display the incoming call time.
13. ◊Special display of the first version of digital filtering: if the value of all the displayed items is wrong or the value exceeds the limit, it will be displayed as "-8888888";
14. **Digital filter second edition, battery-powered special display instructions:
 - A. NULL ---- Do not display this data;
 - B. ERROR ---- The data is wrong. At this time, please check the menu settings;
 - C. OVERRUN -- The data exceeds the displayable range;

Chapter 9 Troubleshooting

No	Malfunctions	Cause	Troubleshooting
1	No signal output	<ol style="list-style-type: none"> 1. There is no medium flow in the pipeline or the flow rate is lower than the lower limit flow rate; 2. The power supply and output cable are not connected correctly; 3. The device is damaged; 	<ol style="list-style-type: none"> 1. Increase the flow rate of the medium or use a small diameter flow meter; 2. Correct wiring; 3. Check or replace the flow meter.
2	With signal output when there is no flow	<ol style="list-style-type: none"> 1. The flow meter is not grounded or other interference; 2. The amplifier sensitivity is too high or self-excited; 3. The power supply is unstable; 	<ol style="list-style-type: none"> 1. Connect the ground wire correctly to eliminate interference; 2. Adjust or replace the amplifier; 3. Repair and replace the power supply to eliminate interference.
3	Instantaneous flow rate display is unstable	<ol style="list-style-type: none"> 1. Medium flow is unstable; 2. There is debris in the pipeline; 3. The sensitivity of the amplifier is too high or too low; 4. Not grounded; 5. The flow rate is lower than the lower limit; 6. The sealing ring extends into the pipeline, forming a disturbance. 	<ol style="list-style-type: none"> 1. Test again after the flow is stable; 2. Eliminate debris; 3. Adjust or replace the amplifier; 4. Check the grounding circuit 5. Increase flow; 6. Change according to installation requirements.

Chapter 10 Parameter Setting

The setting of parameters and debugging information is completed through the cooperation of 4 buttons on the display panel.

1. Navigation keys
- Digital filter type(first edition, second edition)
 - 1) “Set” (K1) : Enter the setting state and confirm the setting value;
 - 2) “Shift” (K2) : Cycle the cursor position to the next digit;
 - 3) “Add” (K3) : add 1 to the value of the cursor or select the function;
 - 4) “Check” (K4) : not needed for parameter setting operation;
 - Battery powered type
 - a)  (K1) : Enter the setting state and confirm the setting value;
 - b)  (K2) : Cycle the cursor position to the next digit;
 - c)  (K3) : add 1 to the value of the cursor or select the function;
 - d)  (K4) : Return to the previous menu item.
 - Parameter setting menu (◇Special to the first edition of digital filter type, ☆
Special to the second edition of digital filter type, ※Special to battery powered
type)
 - 1) Digital filter type(first edition) parameter setting password---1234;
 - 2) Digital filter type(second edition) parameter setting password---120000;
 - 3) Battery powered type parameter setting password-----000000;

Parameter setting menu table 10

Menu name	Menu contents	Description
Factory Reset	Yes, No	Select “yes” and press the setting button. LED displays “please waiting”. Next, it will show “recovery is completed”. Select “no” and enter the lower menu. It is defaulted as “no”.
Measuring menu	Liquid uncompensated Gas uncompensated Gas temperature compensation Superheated steam temperature and pressure compensation Saturation steam temperature compensation Saturation steam pressure compensation Water temperature compensation Liquid temperature subsection compensation Oil temperature pressure compensation Natural air temperature pressure compensation	
Instrument caliber	0000-9999mm	
Instrument factor unit	1/m ³ , 1/L	
Instrument	Average instrument factor	Instrument coefficient setting

factor	Linear instrument coefficient		range: 0.000000-99999999 Linear correction breakpoint frequency setting range: 0.00-9999Hz The setting method of linearity correction is shown in VI
	Linear correction factor	Frequency I	
		Frequency I	
		Frequency II	
		Frequency II	
		
		Frequency X	
Flow unit	m ³ /h, km ³ /h, l/min, kg/h, t/h, kg/min, (Nm ³ /h, Nkm ³ /h, NI/min, Nm ³ /min, Nkm ³ /min)		m ³ /h, km ³ /h, l/min is Volume flow unit for working conditions; kg/h, t/h, kg/min is Mass flow unit; Nm ³ /h, Nkm ³ /h, NI/min, Nm ³ /min, Nkm ³ /min are Volume unit of flow for gas gauge.
	Output Type	Working frequency (Calibration required) Equivalent pulse 4-20mA	
Equivalent coefficient	0.000000-99999999		The equivalent coefficient is meaningful only when the "equivalent pulse" is output. Definition: ** Unit accumulate / pulses
Upper limit of output	0.000000-99999999		The upper limit and lower limit of output are meaningful when the output form is "4-20mA".
Lower limit of output	0.000000-99999999		
Damping coefficient	00-99		
Temperature I	-9999~99999℃		Parameter setting of "liquid temperature segment"
Density I	0.000000-99999999kg/m ³		

Temperature II	-9999~99999℃	compensation” The setting method is shown in VI
Density II	0.000000-99999999kg/m ³	
.....	
Temperature X	-9999~99999℃	
Density X	0.000000-99999999kg/m ³	Parameter setting of natural air temperature pressure compensation
CO ₂ mole fraction	0.000000-99999999	
H ₂ mole fraction	0.000000-99999999	
Relative density	0.000000-99999999	
High calorific power	0.000000-99999999MJ/m ³	
Compression coefficient compensation mode	Automatic setting	
Coefficient of compressibility	0.000000~99999999	The compression coefficient compensation mode is valid when the setting is selected.
Critical pressure	0.000000-99999999MPa	"Gas temperature and pressure compensation", "mixed gas temperature and pressure compensation" parameter setting
Critical temperature	0.000000-99999999K	
Local air pressure	0.000000-99999999MPa	"Local air pressure" defaults 0.101325MPa
Standard temperature	00~99℃	
Temperature compensation method	Automatic setting	
Temperature setting value	-50~430℃	"Temperature compensation mode" is valid when selecting "Settings"

Pressure unit	MPa、KPa、bar	
Pressure compensation mode	Automatic setting	
Setting value of gauge pressure/absolute pressure	-0.1-+20MPa	"Pressure compensation mode" is valid when selecting settings
Medium density	0.000000-99999999kg/m ³	No compensation mode: set to medium condition density; Gas temperature pressure compensation: set to 0.101325MPa and Standard condition density of temperature; Oil temperature pressure compensation: Set to the density when the absolute pressure is 0.101325MPa and the temperature is 20℃.
Small signal resection unit	Hz, flow unit	
Small signal resection value	0.000000-99999999	
System clock	No, yes	
Time setting	MM/DD/YY 00:00	When the system clock is set to "no", it is not displayed
Communication form	No 485	
Communication bit number	001-255	"Communication bit number" default 001.
Baud rate	9600、4800 2400、1200	"Baud rate" defaults 9600

Parity check	No check even parity check odd parity check	“Parity check” defaults “no”
Stop bit	1 bit、2 bit	“stop bit” defaults “1”
Backlight display mode	Normally closed, normally open, automatic	
Parameter storage	Yes, no	Press  for 2-3 seconds to exit from “parameter setting” menu. Select “yes” and the screen will display “success in parameter storage” and return to main menu.

- Note: 1. The table lists all the menu items in the software, which are not all displayed in general; Depending on the function and settings, certain menu items are blocked;
2. When you enter the menu, you may find that a value is different from the original setting. It is normal that LED display has not been refreshed. Press K2 button to recover to normal.
3. Cumulative clear
“Cumulative clear” menu clears accumulated traffic and power loss records.

Chapter 11 Setting Of Signal Output

1. Digital filter first version signal output setting method
 - 1) Working condition pulse or communication: DIP switch 3 is turned on, and the rest are closed; the software selects "working condition pulse";
 - 2) Standard condition pulse: DIP switch 3 is turned on, and the rest are closed; the software selects "standard condition pulse";
 - 3) Two-wire 4-20mA current: DIP switches 1, 2 are on, the rest are off; the software selects "current";

2. Digital filter second edition signal output setting method
 - 1) Two-wire current: DIP switches 1, 2 are on, and the rest are off; the software selects "two-wire current";
 - 2) Three-wire current: DIP switches 1, 2, and 8 are off, and the rest are on; the software selects "three-wire current";
 - 3) Pulse output: DIP switches 1, 2, 8 are closed, and the rest are open; the software selects the corresponding pulse output form;
 - 4) RS485 communication: DIP switches 1, 2 are closed, and the rest are open; the software selects "485" (in the case of 485 communication, "two-wire current" cannot be selected);

3. Setting method of battery-powered signal output (the DIP switch is located on the motherboard)
 - 1) Working condition frequency: the menu selects "working condition frequency"; DIP switches 1, 3, 4 are on, the rest are off, J1 'F0' sign
 - 2) Short-circuit the terminal; when the OC gate is output, the J1 'OC' terminal is short-circuited;
 - 3) Equivalent pulse: the menu selects "equivalent pulse"; DIP switches 1, 3, 4 are turned on, the rest are closed, and J1 'F0' sign
 - 4) Short-circuit the terminal; when the OC gate is output, the J1 'OC' terminal is short-circuited;
 - 5) Two-wire current: the menu selects "two-wire current" or "current percentage"; DIP switch 4 is turned on, and the rest are turned off;

- 6) Communication output: select "485" in the menu "Communication Type"; the DIP switches 2, 3, 4 are on, and the rest are off;
- 7) Simultaneous output of communication and frequency: the menu is set correspondingly as described above; DIP switches 1, 2, 3, and 4 are opened, and the J1 'F0' terminal is short-circuited; when the OC gate is output, the J1 'OC' terminal is short-circuited.

Chapter 12 Communication

1. Digital filter type communication method
 - Communication protocol: adopts standard MODBUS-RTU, RS485
 - Data format: standard 4 bit;

Table 11

Start bit: 1 bit	Data bit: 8 bits	Parity check bit: setting
Stop bit: setting	Baud rate: setting	Response speed: 0.05s

- 1) Using the standard MODBUS-RTU communication protocol 03 command, the first version can simultaneously transmit 1~4 continuous data;
- 2) Using the standard MODBUS-RTU communication protocol 03 command, the second version can simultaneously transmit 1~9 continuous data;
- Each data is stored using two 16-bit memories, the corresponding memory addresses are as follows:
 - 1) 0001H~0002H: Instantaneous flow value
 - 2) 0003H~0004H: Cumulative flow value
 - 3) 0005H~0006H: Working condition temperature (No compensation model; 0.0000)
 - 4) 0007H~0008H: Working condition pressure (No compensation model; 0.0000)
 - 5) 0009H~000AH: Output frequency/current
 - 6) 000BH~000CH: Working condition density (When the instantaneous flow is volume flow, the display is 0.0000)
 - 7) 000DH~000EH: Amplifier temperature
 - 8) 000FH~0010H: Input frequency
 - 9) *0011H~0012H: Total power loss time (when the system clock is off, it is 0.0000)
2. Battery powered communication method
 - Data format (standard 4-byte floating point number)

Table 12

Data bit: 8bit	Stop bit: 1bit、2bit (Optional)	Parity check: no/ even/ odd parity check(Optional);
Start bit: 1bit	Baud rate: 1200、2400、4800、9600 (Optional)	Responding speed: 0.05s

- Communication protocol: adopt standard MODBUS-RTU communication protocol;
- Using standard MODBUS-RTU communication protocol 03 command, 1~12 continuous data can be transmitted simultaneously;
- Each data is stored using two 16-bit memories, the corresponding memory addresses are as follows:
 - 1) 0001H~0002H: Instantaneous flow value;
 - 2) 0003H~0004H: Cumulative flow value;
 - 3) 0005H~0006H: Working condition temperature (No compensation model; 0.0000) ;
 - 4) 0007H~0008H: Working condition pressure (No compensation model; 0.0000) ;
 - 5) 0009H~000AH: Operating volume flow rate;
 - 6) 000BH~000CH: Working condition density;
 - 7) 000DH~000EH: Coefficient of compressibility (Nonstandard unit of volume, 0.0000) ;
 - 8) 000FH~0010H: Input frequency
 - 9) 0011H~0012H: Working frequency output (when it is the output, it is 0.0000);
 - 10) 0013H~0014H: Equivalent pulse output (not output, 0.0000);
 - 11) 0015H~0016H: Current output (not output, 0.0000);
 - 12) 0017H~0018H: Current percentage (not this output, 0.0000) ;
 - 13) 0019H~001AH: Gauge temperature;
 - 14) 001BH~001CH: Transfinite cumulative flow (when the protocol metering is off, it is 0.0000);
 - 15) 001DH~001EH: Total power loss time (when the system clock is off, it

is0.0000);

16) 001FH~0020H: Menu modification times;

17) 0021H~0022H: Battery voltage;

3. Special transmission data(Digital Filter type(Second Edition) and battery-powered type only)Transmission data when liquid crystal displays the following information::

1) NULL: Transmit data is 0;

2) ERROR: Transmit data is -1234;

3) OVERRUN: Transmit data is-8888;