

Ultrasonic flow meter

Committed to process automation solutions

Datasheet



1158-J-SUP

Introduction

1158-J-SUP ultrasonic flow meter uses advance circuit design,coupled with excellent hardware designed in English and can be switched surfaces.It is easy to operate and with stable performance. This wall mounted ultrasonic flow meter with clamp on sensor is used in testing equipment filter elements for water purifier. It could be also installed in some residential areas and commonly used for testing water supply and monitoring.With functions like ARM,FPGA chip,low voltage and wide pulse transmission technology design can this ultrasonic flow meter reach a high precision and produce a reliable performance.

Feature



- Without cutting pipes
- Real-time measurement
- Easy operation
- Various piping material available: Carbon steel pipe, stainless steel pipe, PVC pipe
- Wide measuring range: DN25~DN1200
- ARM,FPGA chip and wide pulse transmission technology design
- Wide voltage power supply: 10-36V
- RS485 Communication intelligent remote
- Ingress protection: IP68
- Standard 9m anti-interference shielding line and fully closed design
- Piping material: limited to external clamps,single material;No: lining,PMMA, cement pipe, water scale
- Medium temperature: 0~80℃

Parameter

Performance specifications	
Flow range	0.03 ~ 16 ft/s (0.01 ~ 5.0 m/s).
Accuracy	± 1.0 %.
Pipe size	Clamp-on: 1" ~ 48" (25mm ~ 1200mm).
Fluid	Water
Function specifications	

Outputs	OCT Pulse output: 0-5000Hz. Analog output : 4 ~ 20mA, max load 750Ω.
Communication interface	RS485 MODBUS.
Power supply	10 ~ 36VDC/1A.
Keypad	16 (4×4) key with tactile action.
Display	20×2 lattice alphanumeric, back lit LCD.
Temperature	Transmitter: 14 °F to 122 °F (-10°C ~ 50°C); Transducer: 32 °F to 176 °F (0°C ~ 80°C).
Temperature	Common 0~80°C (80~150°C high temperature optional)
Humidity	Up to 99% RH, non-condensing.
Physical specifications	
Transmitter	PC/ABS, IP65.
Transducer	Encapsulated design, IP68.
Transducer cable	Standard cable length: 30 ft (9m).
Weight	Transmitter: approximately 0.7kg Transducer: approximately 0.4kg

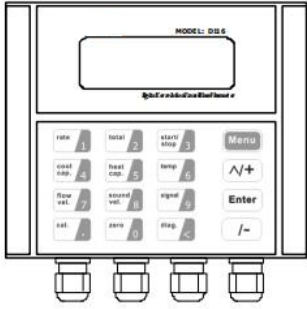
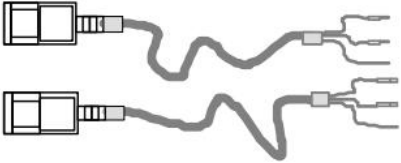
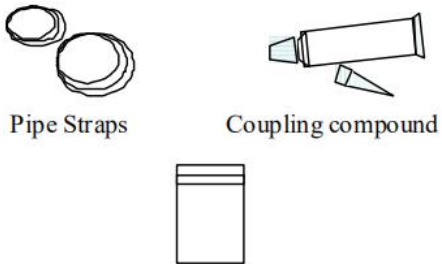
Product overview

Transmitter	Transducers
	
Accessories	Documents
 <p>Pipe Straps</p> <p>Coupling compound</p> <p>Install accessory</p>	 <ol style="list-style-type: none"> 1. Instruction Manual 2. Packing List 3. Position drawing

Application

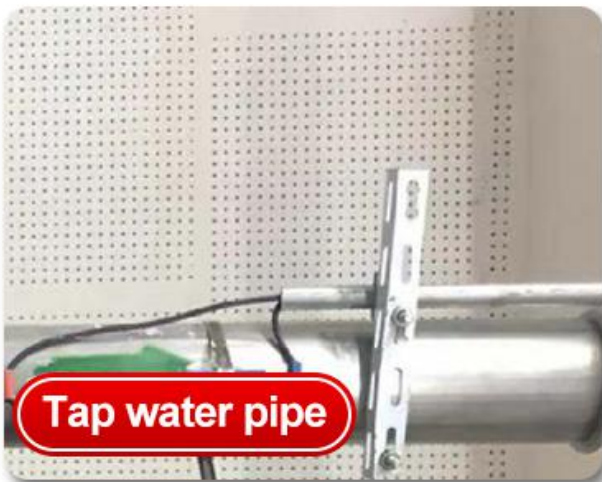

Installation

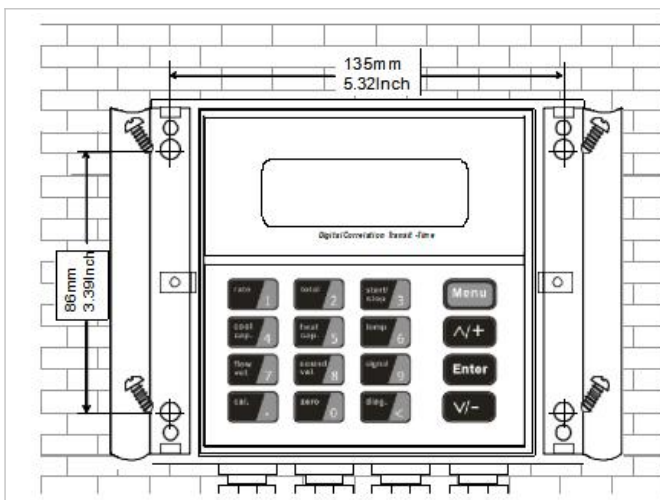

Transmitter

Take out the enclosed screws and plastic bushings. Insert the plastic bushings into the installing holes. Put the flowmeter to the position and screw it in.

Position drawing

1. Place this template on the wall and drill 4 holes of 5mm diameter & 40mm deep.
2. Insert a plastic bushing into each of the 4 holes.
3. Screw 4 pcs PA 4 × 30mm self tapping screws through the transmitter enclosure base and attach it to the wall.
4. Tighten the screws to secure to the enclosure on the wall.

Position drawing

A "Position Drawing" is in the packing. Please use it as a template in the place that you are going to install the Flowmeter. Then drill 4 installing holes at the screws position shown on the drawing with the 5.0mm drill.

Wiring

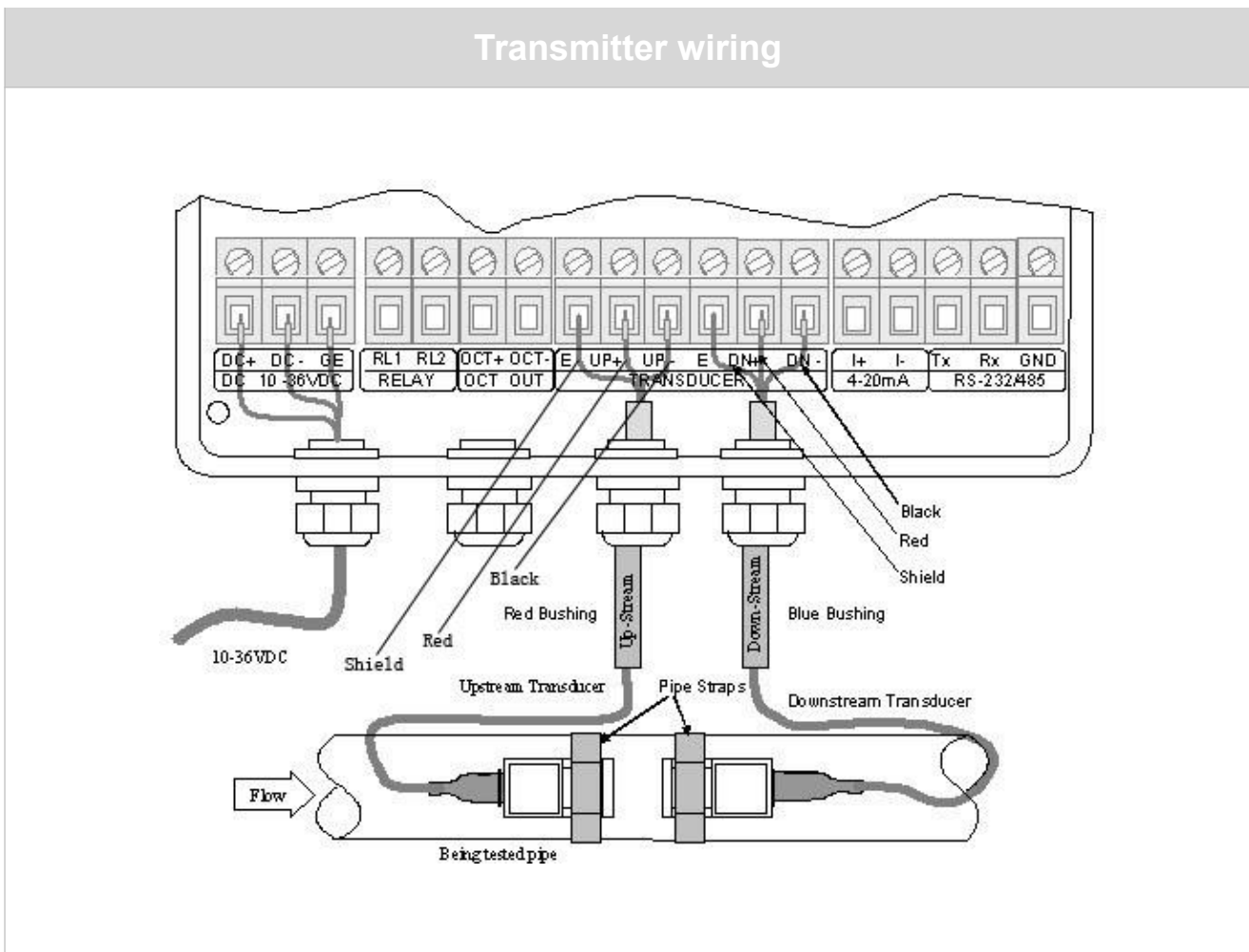

Lengthened cable

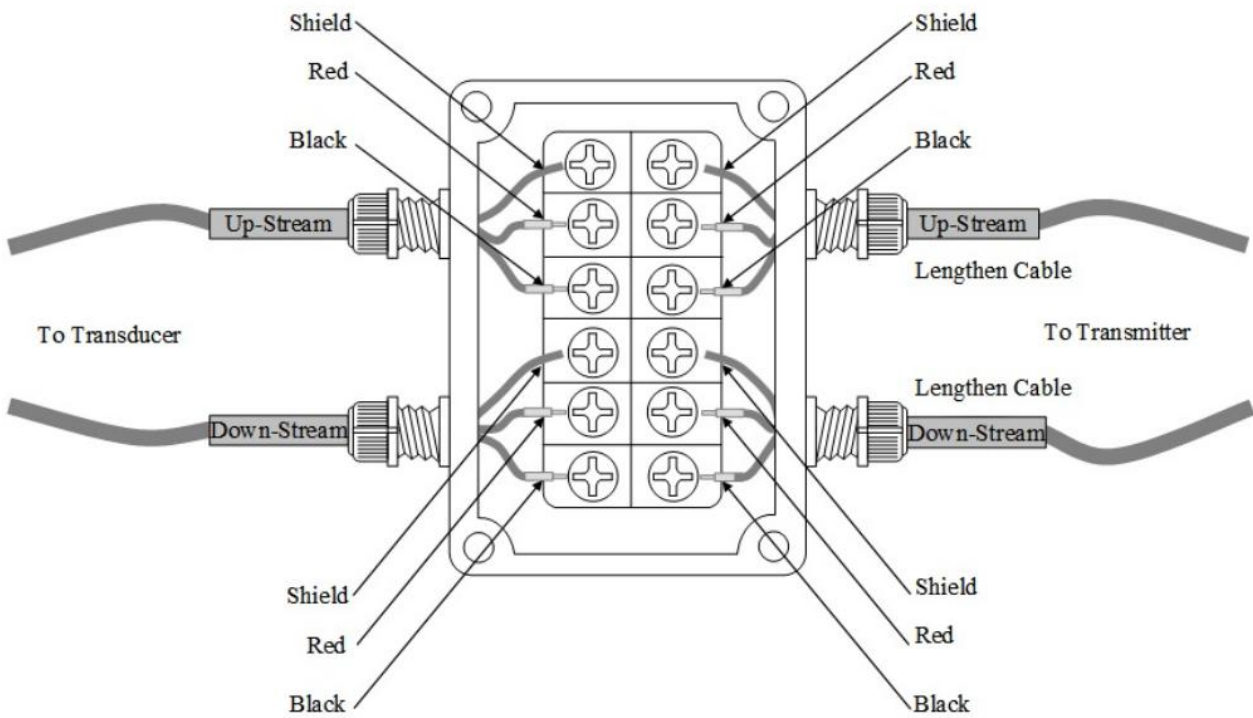

Supmea

Headquarters

5th floor, Building 4, Singapore Hangzhou Science Technology Park, No. 6 street,
Hangzhou Economic Development Area, Hangzhou 310018, China

Singapore

2 Venture Drive #11-30 Vision Exchange Singapore

Philippines

Majestic Subdivision, Lot 1, 1800 Rainbow St, Marikina, 1811 Metro Manila, Philippines

✉ info@supmea.com

🌐 www.supmea.com

Supmea Automation Co., Ltd.
